

1/4" – 2" (DN 8 – 50) ELIMINATOR™ 2000 CWP AND ANSI CLASS 600 THREADED END BALL VALVE

The *Eliminator* ball valve, brings you the performance and design features you've been looking for – all in a single, low-cost valve.

This ball valve's unique design offers fire-test specifications, rugged actuator mounting and flexible-lip seats for application versatility that surpasses other low-cost ball valves.

The *Eliminator* ball valve is available in 1/4" – 2" (DN 8 – 50) sizes in two versions. The first is rated by the traditional approach for threaded end valves. This approach determines Cold Working Pressure (CWP) based on paragraph UG101 of the ASME Boiler and Pressure Vessel Code. Accordingly, the CWP of this series is as follows:

Valve Size		CWP Rating	
inches	DN	psi	bar
1/4" – 2"	8 – 50	2000	138

The second version is rated according to ANSI Standard B16.34. This rugged ANSI design meets all of the requirements of ANSI B16.34 and may be used in ANSI piping systems without compromising ANSI piping codes.

The ratings are as follows:

Valve Size		ANSI Class	CWP Rating	
inches	DN		psi	bar
1/4" – 2"	8 – 50	600	1480	102.1

Both designs are available in carbon and stainless steel and are rated for steam applications with Xtreme® (X), and PTFE (T) seats.

FEATURES

Reliable Bi-Directional Shutoff

- New *Xtreme* seat provides longer life, expanded performance boundaries and greater value.



- Polymeric flexible lip-seat design offers tight shut-off in either direction and extended cycle life with minimum maintenance.
- Available to meet ANSI Class 600 standards per B16.34, B31.1, B31.3, B31.4 and API 608.

Fire-Tested

- Fire-Tite® valves meet API 607 requirements.
- ANSI Class valves meet API 598 requirements.

NEW FEATURES AND BENEFITS

- New patented stem seal system is live loaded and engineered to assure long sealing life.
- ISO 5211 Bonnet for global conformity.
- CE Marking option.
- New stainless steel linkage for VPVL, V-Series and ADC-Series actuators has a guided coupling to align topworks during assembly and eliminate side load stress on stem seals for long life, clean environment and reduced maintenance.

Rugged Valve/Actuator Interface Simplifies Automation

- Jamesbury® actuators and linkage support up to a 200 lb. load in any direction without causing actuator misalignment and consequent stem seal leakage.

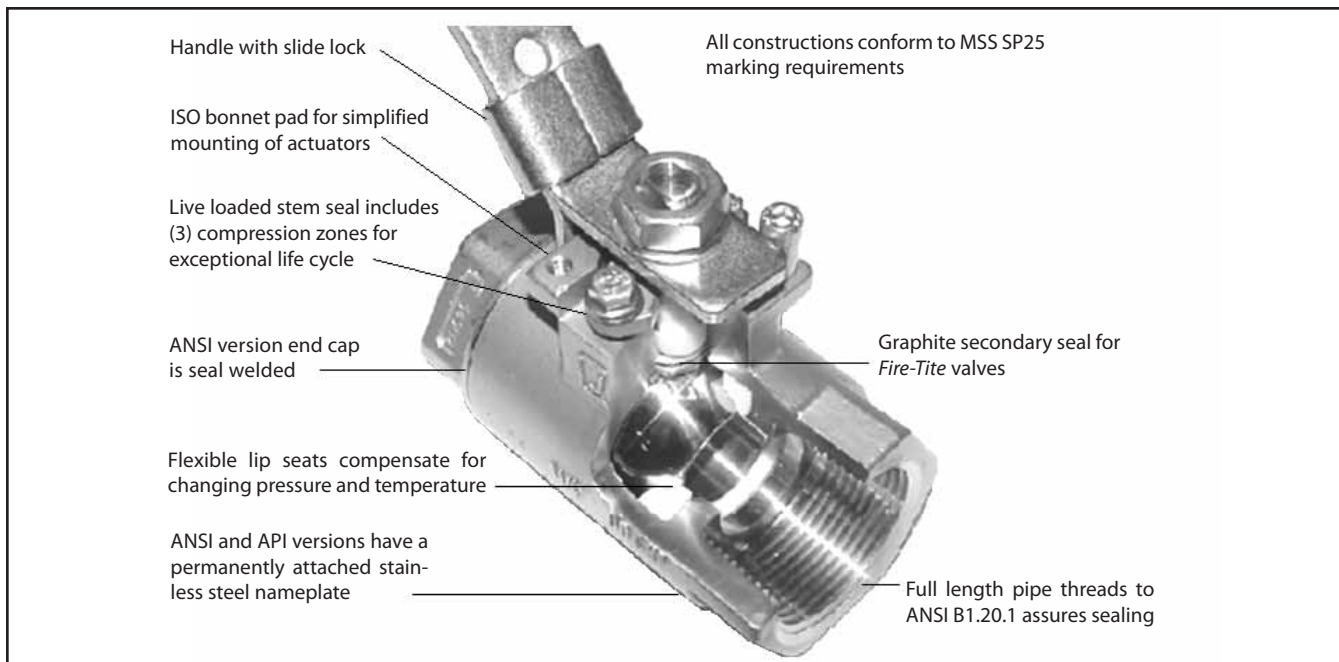

XTREME PERFORMANCE & VALUE

Xtreme seats provide longer life, expanded performance boundaries and the greatest possible value. *Xtreme* is a unique material that resulted from a technological breakthrough in our polymer research lab. The material is a fluoropolymer based blend, proprietary to *Jamesbury* that provides superior quarter turn valve performance.

Valve Seat Ratings

These ratings are based on differential pressure with valve in the fully closed position and refer to seats only. Refer to valve body ratings to be sure that all components are satisfactory for the application.

Valve Body Ratings

These are maximum working pressure ratings of the valve body only. Valves in carbon steel are suitable for service to -20°F (-29°C), valves in 316 stainless steel to -60°F (51°C) (to -40°F with Delrin® seats). The preceding seat ratings determine the practical pressure limit. Ratings are at -20°F to +100°F (-29°C to +38°C).

1 1/4" – 2" (DN 8 – 50) Standard Port

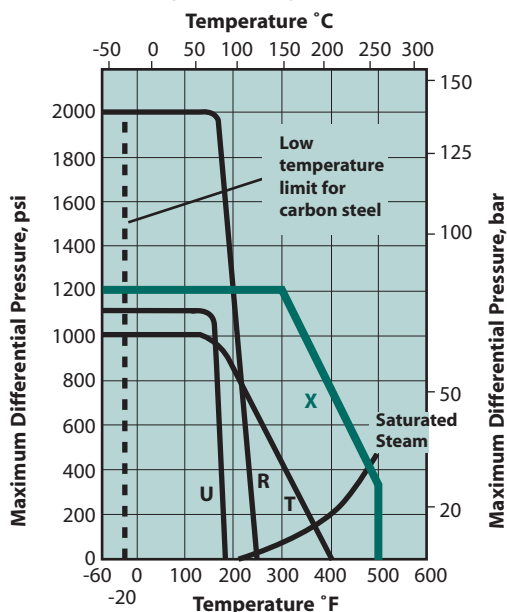

X-Xtreme T-PTFE R-Delrin
U-UHMW Polyethylene

Valve Size inches	Working Pressure Rating - psi			
	Carbon Steel		Stainless Steel	
	ANSI Rated	CWP Rated	ANSI Rated	CWP Rated
1/4" – 2"	1480	2000	1440	2000

Valve Size DN	Working Pressure Rating - bar			
	Carbon Steel		Stainless Steel	
	ANSI Rated	CWP Rated	ANSI Rated	CWP Rated
8 – 50	102	138	99.3	138

**Jamesbury 'The Ultimate Process Automation Package'
for VPVL Pneumatic Actuators, V-Series and ADC-Series Electric Actuators**

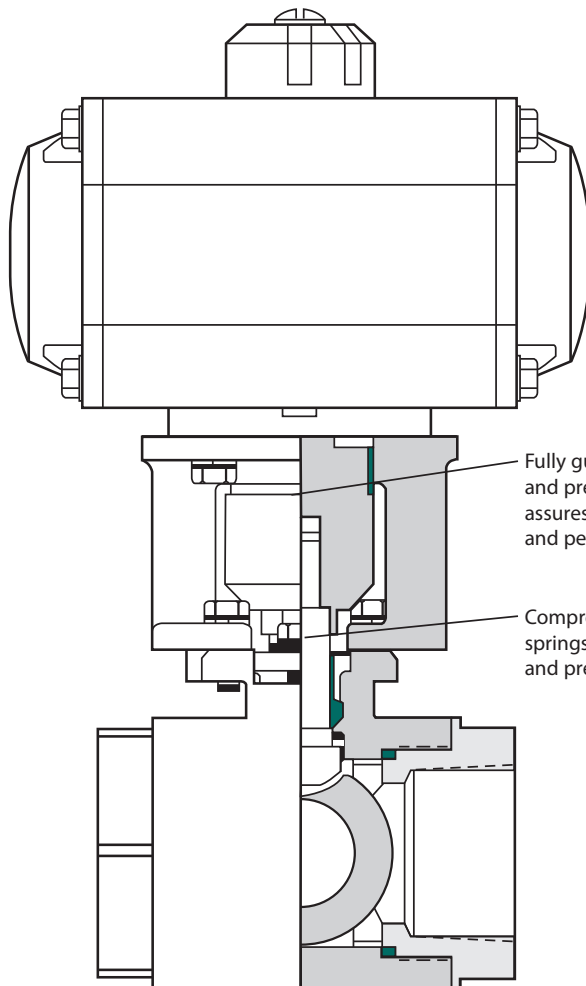

Fully guided stem, coupling and precision bracket assures optimum form, fit and performance

Compression plate and disc springs to accommodate thermal and pressure cycles.

Patented stem seal (70017915) has 3 engineered sealing zones to provide multiple barriers for long term sealing.

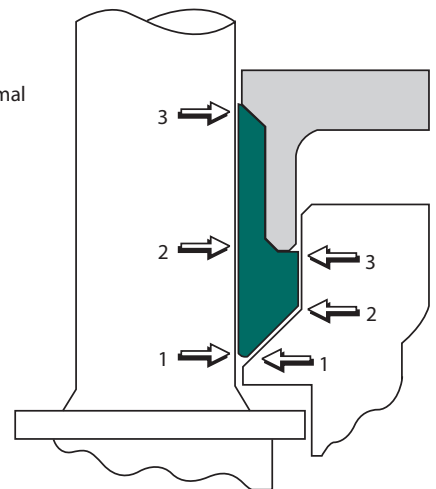

Automation Performance and Value

Eliminator valves combined with *Jamesbury* actuators, offer a total value and performance package. Available with pneumatic Valv-Powr® VPVL actuators, V-Series and ADC-Series electric actuators and with Stonel® Quartz®,

Eclipse®, and Hawkeye® digital monitors or VCTs, the packages have a wide range of applications. Visit our website at www.metso.com/valves.

DIMENSIONS

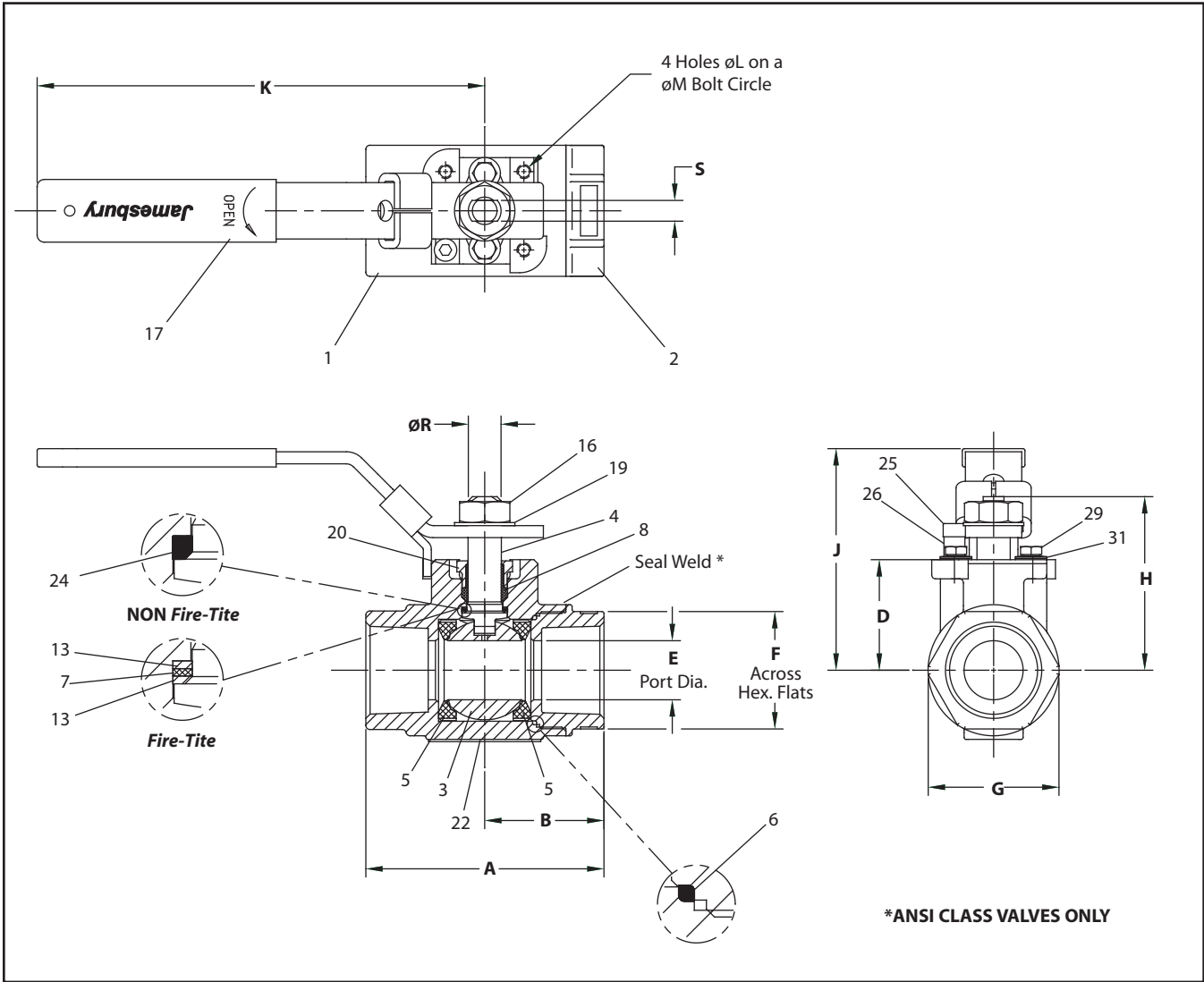

Valve Size Inches	APPROXIMATE DIMENSIONS - inches														Approx. Weight lbs.
	A	B	D	E	F	G	H	J	K	L	M	R	S	ISO BONNET	
1/4	2.16	1.13	1.06	0.43	1.13	1.2	1.63	2.36	5.00	M5	1.42	0.31	0.18	F03	1.0
3/8	2.16	1.13	1.06	0.43	1.13	1.2	1.63	2.36	5.00	M5	1.42	0.31	0.18	F03	1.0
1/2	2.62	1.34	1.06	0.50	1.13	1.2	1.63	2.36	5.00	M5	1.42	0.31	0.18	F03	1.0
3/4	3.00	1.50	1.22	0.69	1.38	1.6	1.79	2.52	5.00	M5	1.42	0.31	0.18	F03	2.0
1	3.55	1.78	1.65	0.88	1.75	2.0	2.58	3.29	6.50	M5	1.65	0.50	0.31	F04	3.0
1-1/4	4.00	2.00	1.78	1.00	2.00	2.3	2.71	3.42	6.50	M5	1.65	0.50	0.31	F04	4.0
1-1/2	4.38	2.19	2.08	1.25	2.31	2.7	3.30	4.27	8.00	M6	1.97	0.63	0.37	F05	5.5
2	5.50	2.75	2.26	1.50	2.81	3.1	3.49	4.46	8.00	M6	1.97	0.63	0.37	F05	7.5

Valve Size DN	APPROXIMATE DIMENSIONS - mm														Approx. Weight kg
	A	B	D	E	F	G	H	J	K	L	M	R	S	ISO BONNET	
08	55	29	27	11	29	31	41	60	127	M5	36	08	05	F03	.4
10	55	29	27	11	29	31	41	60	127	M5	36	08	05	F03	.4
15	67	34	27	13	29	31	41	60	127	M5	36	08	05	F03	.4
20	76	38	31	18	35	41	45	64	127	M5	36	08	05	F03	.9
25	90	45	42	22	44	51	65	84	165	M5	42	13	08	F04	1.3
32	102	51	45	25	51	59	69	87	165	M5	42	13	08	F04	1.8
40	111	56	53	32	59	69	84	108	203	M6	50	16	09	F05	2.5
50	140	70	57	38	71	79	89	113	203	M6	50	16	09	F05	3.4

BILL OF MATERIALS AND PARTS LIST			
Part No.	Part Name	Body Material	
		Carbon Steel (22)	316 Stainless Steel (36)
1	Body	Carbon steel ASTM A216 Type WCB	316 Stainless steel ASTM A351 Type CF8M
2	Body Cap	Carbon steel ASTM A216 Type WCB	316 Stainless steel ASTM A351 Type CF8M
3	Ball	316 Stainless steel	
4	Stem	316 Stainless steel or 17-4 PH Stainless steel	
5	Seat	PTFE, Xtreme, Delrin [®] , UHMW polyethylene, as specified	
6	Body Seal	TFM, UHMWPE (w/UHMWPE seats) ¹	
7	Secondary Stem Seal	Graphite*	
8	Stem Seal	PTFE, TFM [®] (Xtreme seated valves), UHMWPE (w/UHMWPE seats)	
13	Stem Bearing	PTFE (w/PTFE or Delrin seats), Filled PTFE (w/Xtreme seats), UHMWPE (w/UHMWPE seats)	
16	Hex Nut	316 Stainless steel	
17	Handle	Carbon steel (Zinc plated)	300 Series Stainless steel
19	Lock Washer	300 Series Stainless steel	
20	Compression Plate	316 Stainless steel (Monel [®] if chlorine)	
22	Identification Tag [†]	316 Stainless steel	
25	Socket Cap Screw	316 Stainless steel	
26	Handle Stop Spacer	316 Stainless steel	
29	Hex Cap Screw	316 Stainless steel (Monel if chlorine or NACE)	
31	Disc Springs	Inconel	

* Item 7 not applicable in non Fire-Tite valves.

Requires 17-4 PH stem

† ANSI Valves

1. ANSI rated valves use graphite body seals.

ACCESSORIES

Bonnet Extension SE-096, 097 & 098

4" (102 mm) bonnet extensions are available for applications that require insulated pipe, particularly useful for automated products, bonnet extension can also be used to prevent interference between actuators and companion pipelines and equipment. They are ideal as extension that require locking lever or locking oval handle capability. Stainless steel construction offers the option of using the bonnet extension to enhance the carbon steel stem extension (SE-093, 094 & 095) offerings.

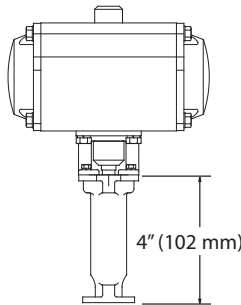

Stem Extensions SE-093, 094 & 095

A standard 4" (102 mm) stem extension is offered for improved accessibility, particularly when used in insulated pipelines. Stem extension kits can be ordered factory-mounted or shipped separately for field mounting.

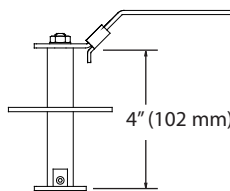

Round Handles

Optional round handles available. To order handles separately, specify the part number shown in the accessories table below.

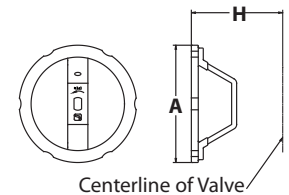

Oval handles with slide-lock

Optional oval handle saves space and may be pad-locked to retain the valve in the open or closed position.

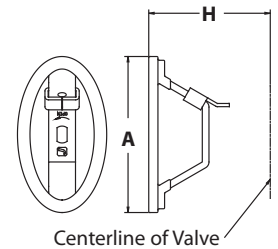

Stainless steel linkages for Jamesbury ISO Actuators

- Self aligning
- Engineered for optimum stem seal performance

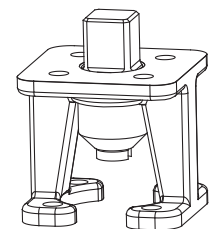

Accessories Table - inches (DN/mm)								
Valve Size Standard Bore	Bonnet Ext.*	Stem Ext.	Locking Oval	Round	Round/Oval Handle		Allowable Max. Torque FT•LBS	
					Dimension A	Dimension H	Round	Oval
1/4 - 1/2 (8 - 15)	SE-096	SE-093	112-0108-30	112-0105-30	4.00 (101.6)	2.96 (75.2)	9 (14)	9 (14)
3/4 (20)	SE-096	SE-093	112-0108-30	112-0105-30	4.00 (101.6)	3.11 (79.0)	9 (14)	9 (14)
1 (25)	SE-097	SE-094	112-0109-30	112-0106-30	4.50 (114.3)	3.70 (94.0)	18 (25)	18 (25)
1-1/4 (32)	SE-097	SE-094	112-0109-30	112-0106-30	4.50 (114.3)	3.83 (97.3)	18 (25)	18 (25)
1-1/2 (40)	SE-098	SE-095	112-0110-30	112-0107-30	5.75 (146.0)	4.75 (120.7)	25 (34)	25 (34)
2 (50)	SE-098	SE-095	112-0110-30	112-0107-30	5.75 (146.0)	4.94 (125.5)	25 (34)	25 (34)

* For valves with Delrin[®] seats, use bonnet extension SE-096, SE-097, SE-098

VALVE TORQUE DATA

These torque charts for *Eliminator* valves are to be used as a guide for actuator selection. Additional requirements may be imposed by media characteristics, trim, and frequency of valve operation. For clean lubricating fluid service, required torque of *Xtreme* (X), and PTFE (T) seated valves only may be reduced 20% when the valve is equipped with

corrosion resistant trim. For difficult services such as slurries and semi-solids, and for oxygen, increase values by 50%. *If in doubt, select the larger actuator.*

Torque output values and actuator selection tables for the different types of *Jamesbury* actuators are contained in the bulletins listed on Page 7.

Xtreme (X) Seated Standard-Port Valves
Maximum Differential Pressure — bar

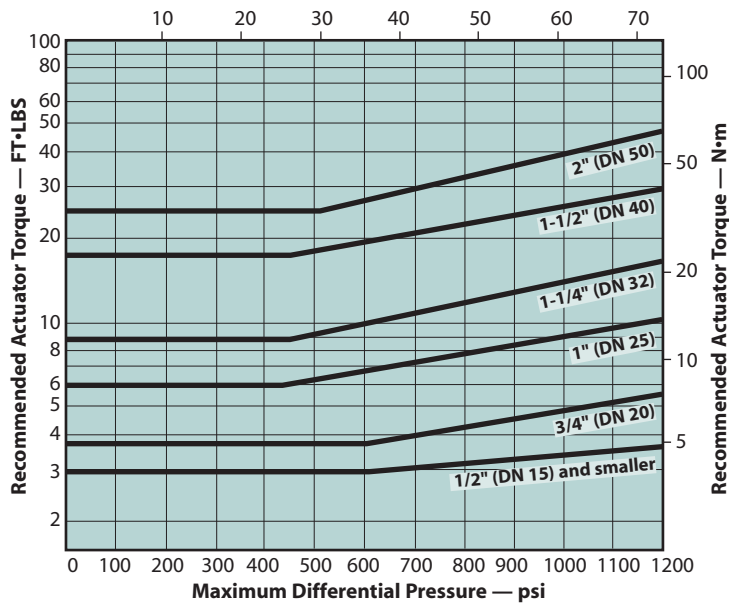

Delrin Seated Valves
Maximum Differential Pressure — bar

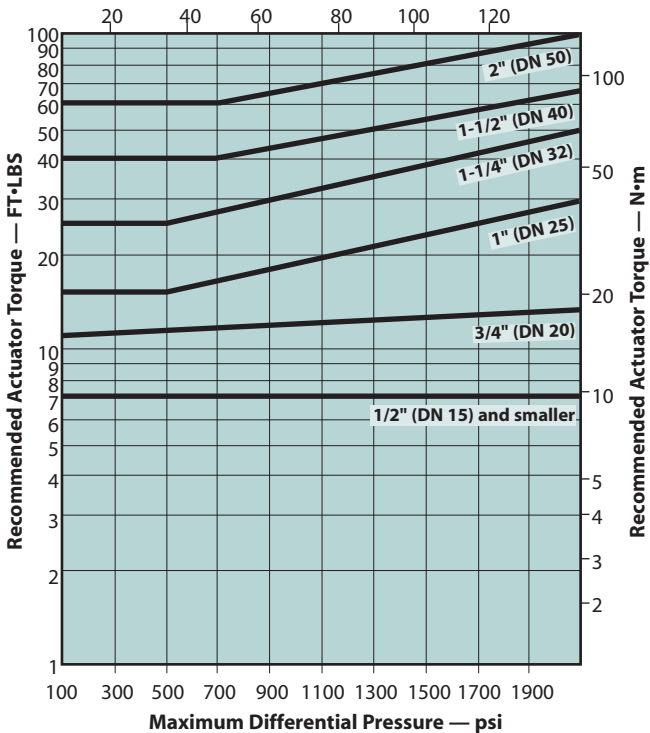

PTFE (T) Seated Valves
Maximum Differential Pressure — bar

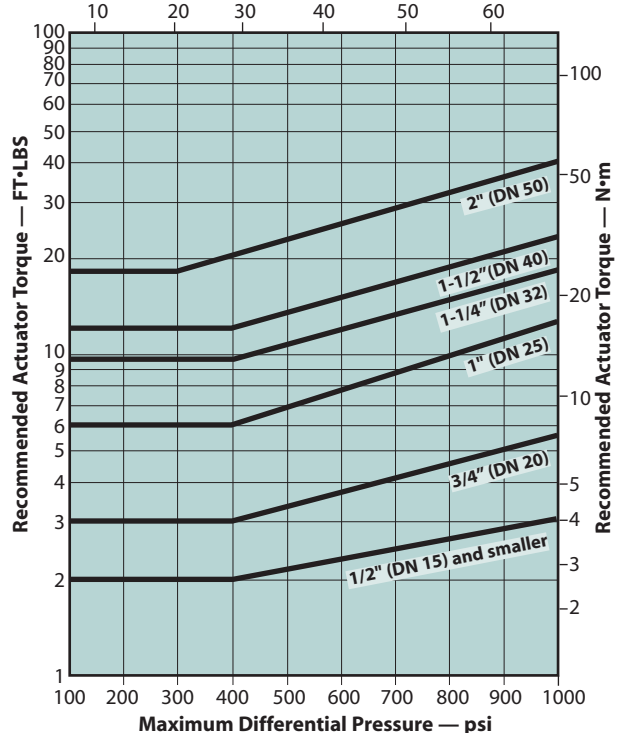

VALVE TORQUE DATA (CONTINUED)

UHMW (U) Polyethylene Seated Standard Port Valves

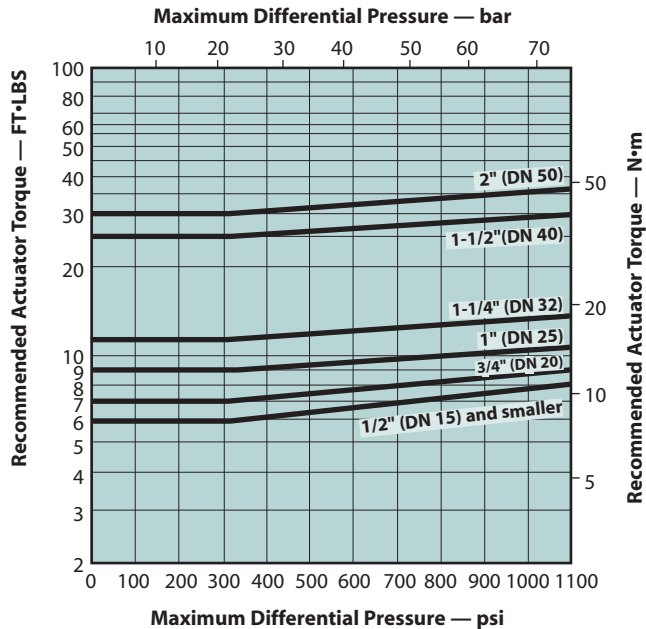

Actuators

Metso offers a full line of integrally designed actuators for automated systems or for easier control of inaccessible or remote valves. Pneumatic actuators that include double-acting and spring-return piston, vane and rack and pinion units, spring-diaphragm types, and electric actuators are available for all valves. Electric actuators are available in both watertight and hazardous location models. For further

information on actuators for *Eliminator* valves, see the following:

Type

- Spring Diaphragm Rotary Actuators
- Double Opposed Piston Actuators
- V-Series Electric Actuators
- ADC-Series Electric Actuators

Bulletin

- A110-4
- A111-5
- A200-1
- A201-1

STANDARDS AND SPECIFICATIONS

Eliminator valves are available in types that meet the following industry specifications.

Specification	Description
ANSI B1.20.1	Pipe Threads
ANSI B16.11	Steel Fitting Socket Welding and Thread
ANSI B16.34	Valves-Flanged and Buttwelding Ends
ANSI B31.4	Liquid Petroleum Piping
API 598	Valve Inspection and Testing
API 607	Fire Test for Soft-seated Valves (Div. of Refining)

Specification	Description
API 608	Metal Ball Valves, Flanged, Threaded and Welded End
MSS SP-25	Standard Marking System for Valves
MSS SP-55	Quality Standard for Steel Fittings for Valves
NACE MR-0103-2003	Materials Resistant to Sulfide Stress Cracking in Corrosive Petroleum Refining Environments

Flow Data

The table below provides flow coefficients of reduced port *Eliminator* valves. The Cv values represent the flow of water at +60°F through the valve in gallons per minute at a pressure drop of 1 psi. The metric equivalent, Kv, is the flow of water at 16°C through the valve in cubic meters per hour at a pressure drop of 1 kg/cm². To convert Cv to Kv multiply by 0.8569.

Valve Size		Cv	Equivalent length of pipe - ft.
inches	DN		
1/4	8	6	.33
3/8	10	10	.61
1/2	15	13	1.5
3/4	20	33	1.1
1	25	44	2.1
1-1/4	32	46	8.4
1-1/2	40	95	4.5
2	50	111	12.0

HOW TO ORDER *ELIMINATOR* BALL VALVES

To specify a valve select the body style, the combination of body and trim material and the proper seat material for the application.

1	2	3	4	5	6	7	8
1-1/2	9F	A	-	22	36	XT	B

Example: This example is for a 1-1/2" *Fire-Tite* ANSI Class 600 NPT ball valve constructed of carbon steel body, stainless steel ball and stem, *Xtreme* seats, TFM seals, Model Code B.

1	Valve Size	
	inches	DN
1/4	1/4	8
3/8	3/8	10
1/2	1/2	15
3/4	3/4	20
1	1	25
1-1/4	1-1/4	32
1-1/2	1-1/2	40
2	2	50

2	Valve Size & Configuration
9F*	<i>Fire-Tite</i> Standard
9N	Non <i>Fire-Tite</i>

3	Pressure Class Conformance
A*	ANSI Class
B	Non-ANSI-Class
M**	ANSI Class with Metric Nameplate

4	Special Application/Construction or Service
-	Standard
O	Oxygen
N	NACE MR0103
C	Chlorine
V	High Vacuum
VC	High Vacuum Certified
TG	Top Ground
STGR	Top & Bottom Ground

5	Body Material
22	Carbon Steel (WCB)
36	316 Stainless Steel (CF8M)

6	Ball & Stem Material
00	Same material as body (Carbon steel not available)
36	316 Stainless Steel
71	Monel
73	Hastelloy C
HB	316 SS Ball/17-4PH Stem

7	Seat & Seal Material	
	Seats	Seal (Stem & Body)
Standard <i>Fire-Tite</i> Options		
TT	PTFE	PTFE & TFM ²
XT	<i>Xtreme</i>	TFM ²
Non <i>Fire-Tite</i> Options		
UU	UHMW Polyethylene	UHMW PE
RT ¹	Delrin (Not for ANSI or NACE, 17-4 PH stem required)	PTFE & TFM

8	Valve Model
B	<i>Eliminator</i> Model B

* For seal welded valves specify ANSI Class (A) in box 3.

** Valves larger than 1" (DN 25) are CE marked.

- 1 Not a self-relieving seat design.
- 2 Seal Welded ANSI rated valves use graphite material body seal.

Delrin® is a registered trademark of DuPont Co.

Monel® is a registered trademark of Inco

Hastelloy® is a registered trademark of Haynes International

TFM® is a registered trademark of Dyneon Co.

Subject to change without prior notice.

Metso Automation Inc.

Europe, Vanha Porvoontie 229, P.O. Box 304, FI-01301 Vantaa, Finland.
Tel. +358 20 483 150. Fax +358 20 483 151

North America, 44 Bowditch Drive, P.O. Box 8044, Shrewsbury, MA 01545, USA.
Tel. +1 508 852 0200. Fax +1 508 852 8172

South America, Av. Independência, 2500- Iporanga, 18087-101, Sorocaba-São Paulo
Brazil. Tel. +55 15 2102 9700. Fax +55 15 2102 9748/49

Asia Pacific, 20 Kallang Avenue, Lobby B, #06-00, PICO Creative Centre, Singapore 339411, Singapore.
Tel. +65 6511 1011. Fax +65 6250 0830

China, 19/F, the Exchange Beijing, No. 118, Jianguo Lu Yi, Chaoyang Dist, 100022 Beijing, China.
Tel. +86-10-6566-6600. Fax +86-10-6566-2575

Middle East, Roundabout 8, Unit AB-07, P.O. Box 17175, Jebel Ali Freezone, Dubai,
United Arab Emirates. Tel. +971 4 883 6974. Fax +971 4 883 6836

www.metso.com/valves

